

Article number: 0110042

Description: Retaining ring JS 25x1,5
Springsteel

Measures

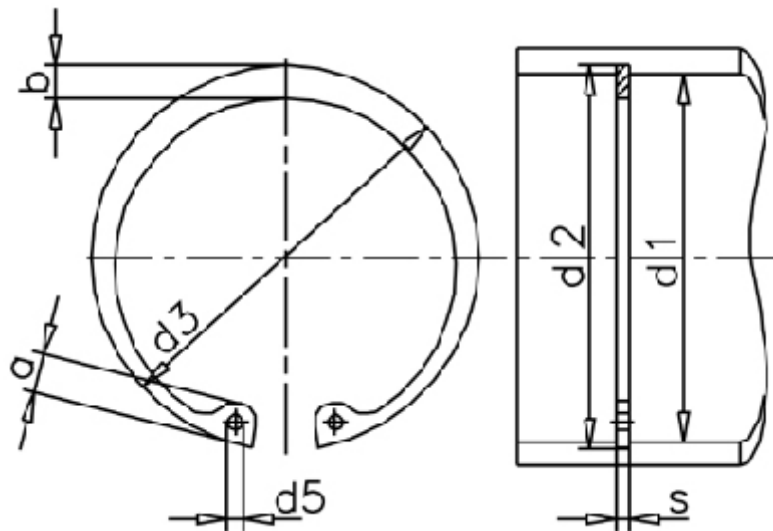

a max = 5.0	Description = JS 25	t = 0.60
AN mm ² = 48	FN kN = 8.0	tol = 0.20
B = 1.60	FRg kN = 7.3	tol = +0,42 -0,21
b = 3.1	FR kN = 22.8	tol = -0.06
d1 = 25	g = 1.0	Tong = ZGJ-2
d2 = 26.2	m min = 1.60	Weight kg/1000 = 2.1
d3 = 26.9	Nominal drive = 1.8	
d5 min = 2.0	s = 1.50	